

特点

2500V

350A

400A

典型应用

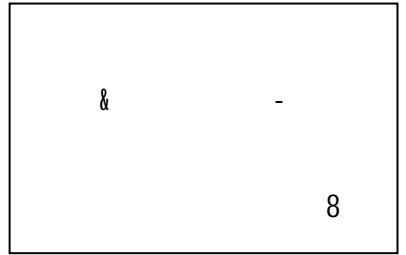

UPS

!							
"						#	
\$&\$							&'
\$(&\$			)				&'
)							
)			*				
)							
+,-							&/
+..+						#	&/
(0							
1							2-
							2-
3	储					-#	
/							4
!' 5(67							

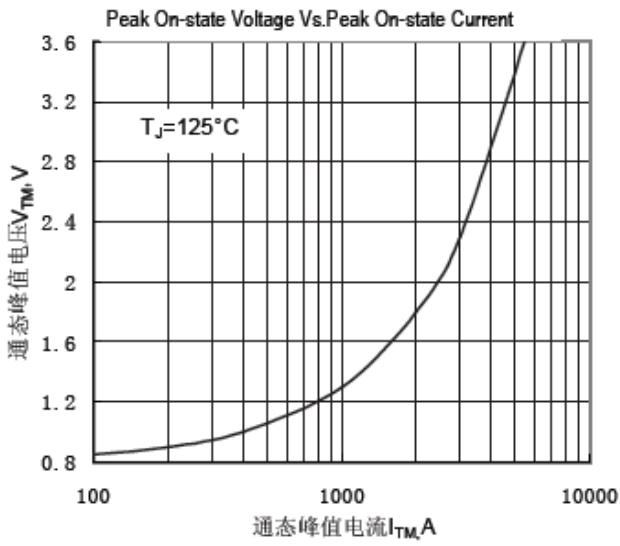

Fig.1

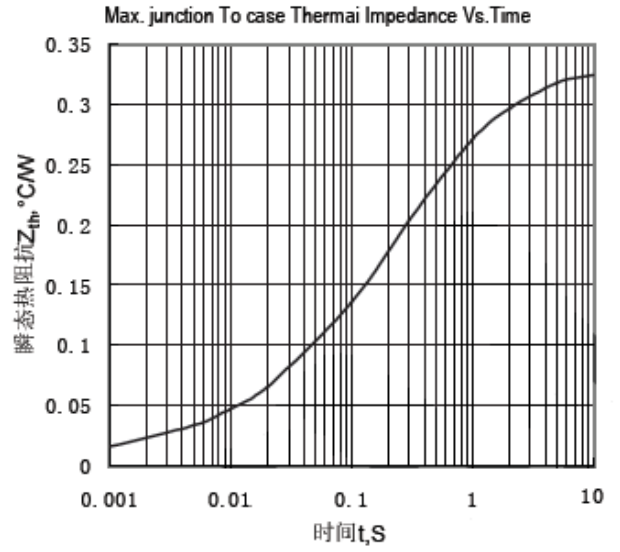

Fig.2 结至管壳瞬 热阻抗

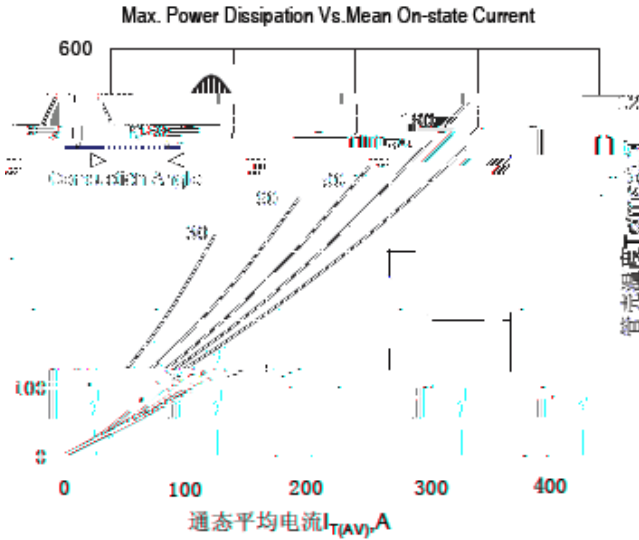

Fig.3 最大功耗与平均电流关系

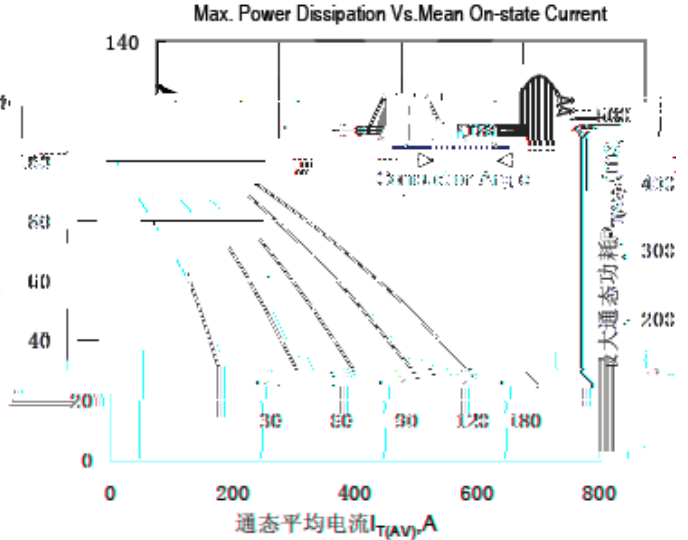

Fig.4 管壳温度与 平均电流关系

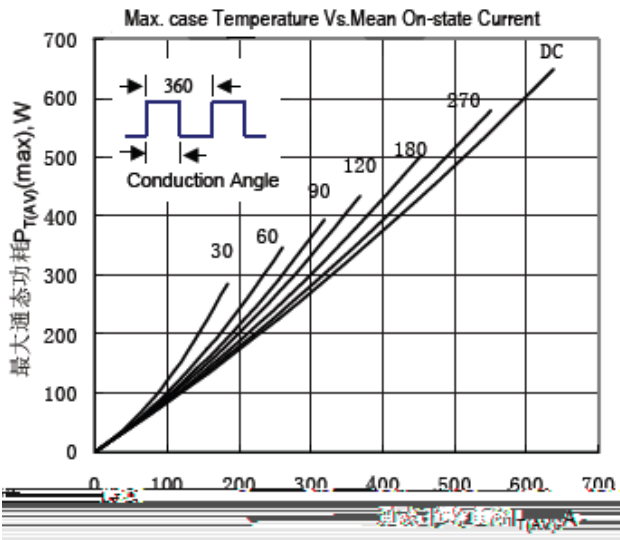

Fig.5 最大功耗与平均电流关系

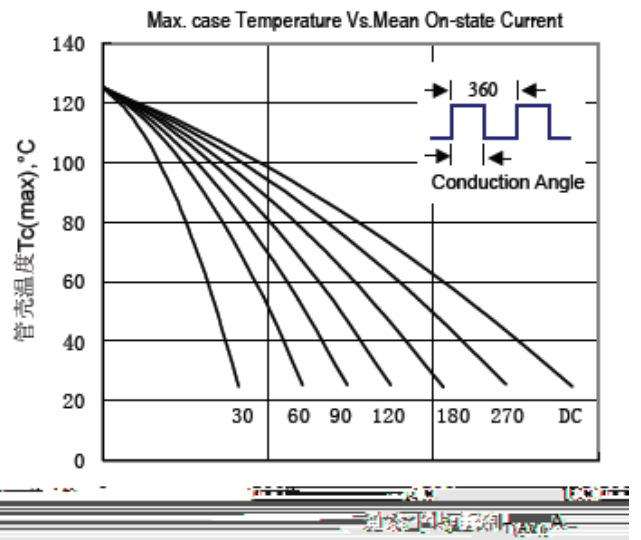

Fig.6 管壳温度与 平均电流关系

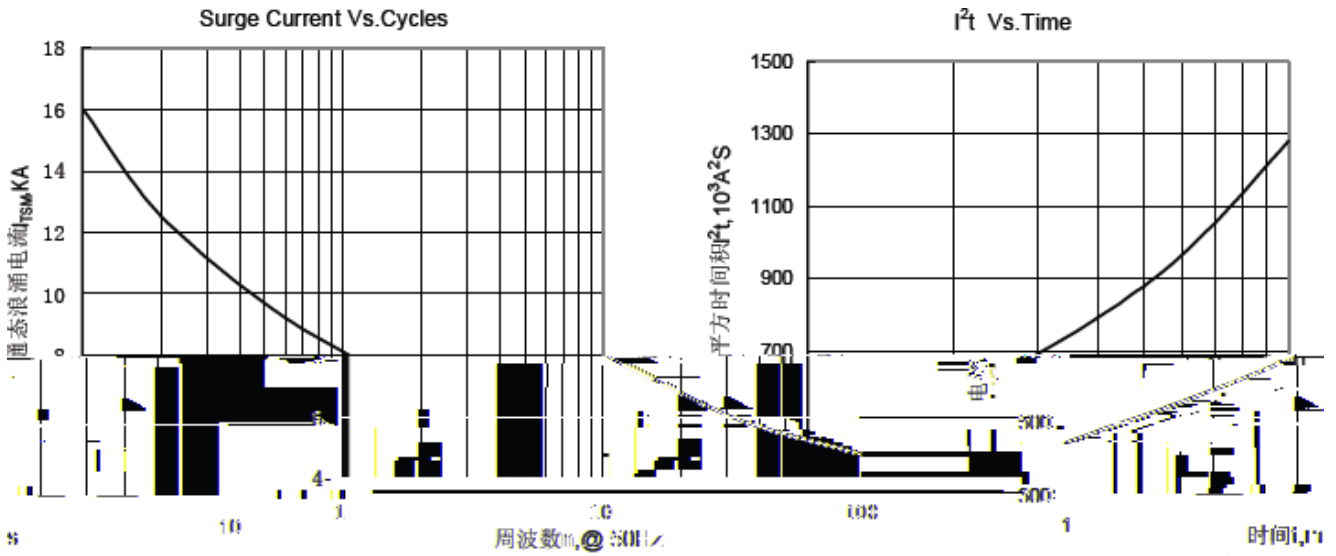

Fig.7 浪涌电流与周波数的关系

Fig.8  $I^2t$

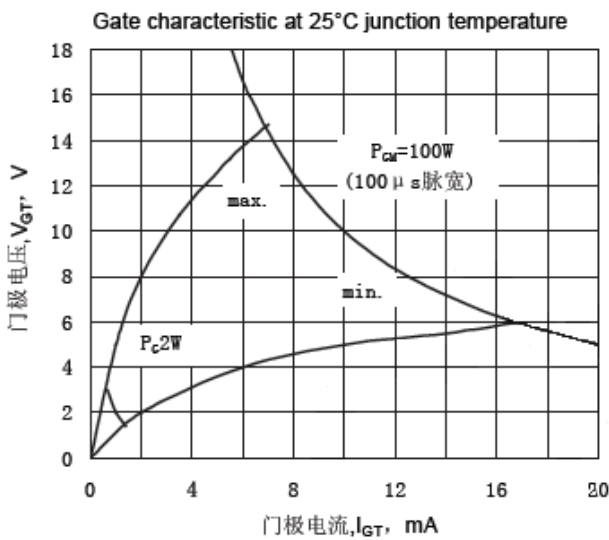

Fig.9 门极功率

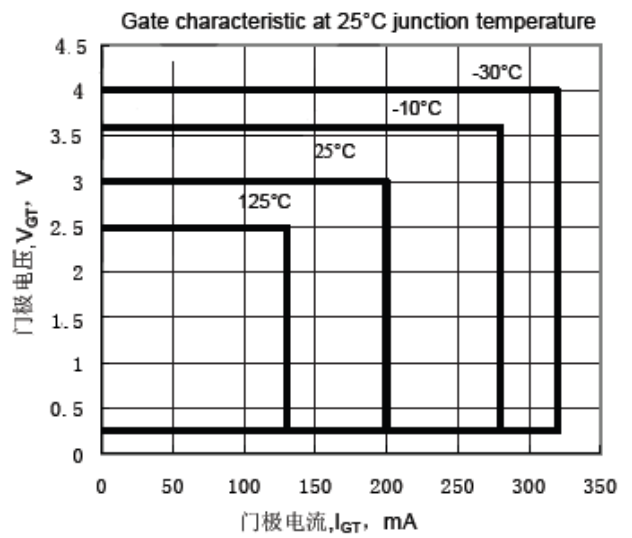
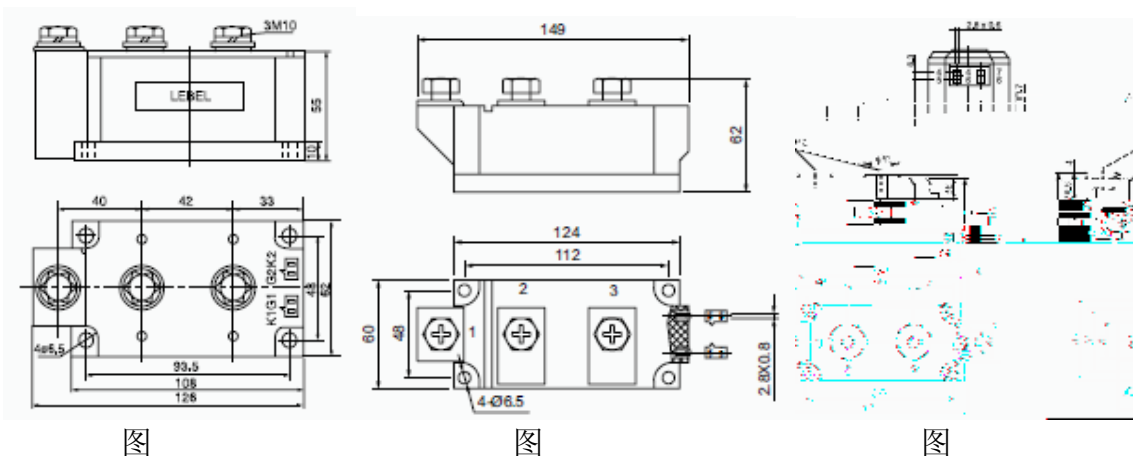

Fig.10 门极触发

外形图:



路图：

